

16ch DIGITAL VIDEO RECORDER

ZR-DH1621NP

INSTRUCTION MANUAL



Before connecting, operating or adjusting this product,
read this instruction booklet carefully and
completely.

© 2004 CBC Co., Ltd. All rights reserved.

First Edition (September 2004)

COPYRIGHT

No part of this document may be reproduced or distributed in any form or by any means without the express written permission of CBC Co., Ltd. (hereafter 'CBC').

TRADEMARKS

GANZ is a registered trademark of CBC Co., Ltd.



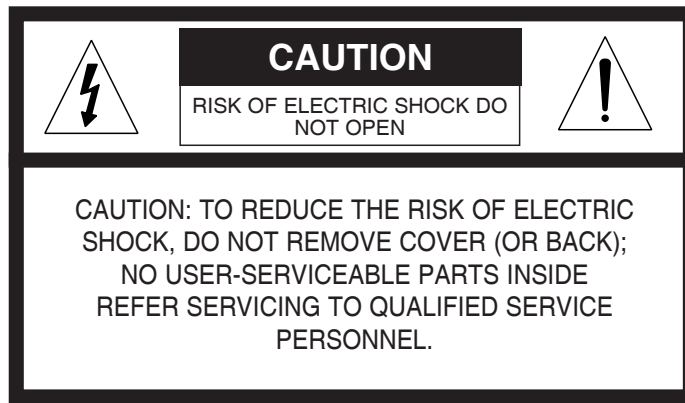

Graphic Symbol Explanation

This lightning flash with arrowhead symbol within an equilateral triangle is intended to alert the user to the presence of uninsulated dangerous voltage within the product's enclosure that may be of sufficient magnitude to constitute a risk of electric shock to persons.

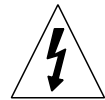

The exclamation point within an equilateral triangle is intended to alert the user to the presence of important operating and maintenance (servicing) instructions in the literature accompanying the product.



This product is manufactured to comply with the radio interference requirements of EEC DIRECTIVE 89/336/EEC, 93/68/EEC and 73/23/EEC.

THIS DEVICE COMPLIES WITH PART 15 OF THE FCC RULES. OPERATION IS SUBJECT TO THE FOLLOWING TWO CONDITIONS: (1) THIS DEVICE MAY NOT CAUSE HARMFUL INTERFERENCE, AND (2) THIS DEVICE MUST ACCEPT ANY INTERFERENCE RECEIVED, INCLUDING INTERFERENCE THAT MAY CAUSE UNDESIRE OPERATION.

This equipment has been tested and found to comply with the limit for a Class A digital device, pursuant to part 15 of the FCC Rules. These limits are designed to provide reasonable protection against harmful commercial environment. This equipment generates, uses, and can radiate radio frequency energy and, if not installed and used in accordance with the instruction manual, may cause harmful interface to radio communications.

Operation of this equipment in a residential area is likely to cause harmful interface in which case the user will be required to correct the interface at his own expense.

Warning

TO PREVENT FIRE OR SHOCK HAZARDS, DO NOT EXPOSE THIS PRODUCT TO RAIN OR MOISTURE. Apparatus shall not be exposed to dripping or splashing and no object filled with liquids, such as vases, shall be placed on the apparatus.

Wiring methods shall be in accordance with the National Electric Code, ANSI/NFPA 70.

IMPORTANT SAFETY INSTRUCTIONS

CAUTION: PLEASE READ AND OBSERVE ALL WARNINGS AND INSTRUCTIONS IN THIS INSTALLATION AND OPERATING GUIDE AND THOSE MARKED ON THE UNIT. RETAIN THIS GUIDE FOR FUTURE REFERENCE.

This set has been designed and manufactured to assure personal safety. Improper use can result in electric shock or fire hazard. The safeguards incorporated in this unit will protect you if you observe the following procedures for installation, use, and servicing. This unit does not contain any parts that can be repaired by the user.

DO NOT REMOVE THE CABINET COVER, OR YOU MAY BE EXPOSED TO DANGEROUS VOLTAGE. REFER SERVICING TO QUALIFIED SERVICE PERSONNEL ONLY.

- 1. Read these instructions.** - All these safety and operating instructions should be read before the product is operated.
- 2. Keep these instructions.** - The safety, operating and use instructions should be retained for future reference.
- 3. Heed all warnings.** - All warnings on the product and in the operating instructions should be adhered to.
- 4. Follow all instructions.** - All operating and usage instructions should be followed.
- 5. Do not use this apparatus near water.** - For example: near a bath tub, wash bowl, kitchen sink, laundry tub, in a wet basement; near a swimming pool; etc.
- 6. Clean only with dry cloth.** - Unplug this product from the wall outlet before cleaning. Do not use liquid cleaners.
- 7. Do not block any ventilation openings. Install in accordance with the manufacturer's instructions.** - Slots and openings in the cabinet are provided for ventilation, to ensure reliable operation of the product, and to protect it from over-heating. The openings should never be blocked by placing the product on a bed, sofa, rug or other similar surface. This product should not be placed in a built-in installation such as a bookcase or rack unless proper ventilation is provided and the manufacturer's instructions have been adhered to.
- 8. Do not install near any heat sources such as radiators, heat registers, stoves, or other apparatus (including amplifiers) that produce heat.**
- 9. Do not defeat the safety purpose of the polarized or grounding-type plug.** A polarized plug has two blades with one wider than the other. A grounding type plug has two blades and a third grounding prong. The wide blade or the third prong are provided for your safety. If the provided plug does not fit into your outlet, consult an electrician for replacement of the obsolete outlet.
- 10. Protect the power cord from being walked on or pinched particularly at plugs, convenience receptacles, and the point where they exit from the apparatus.**
- 11. Only use attachments/accessories specified by the manufacturer.**
- 12. Use only the cart, stand, tripod, bracket, or table specified by the manufacturer, or sold with apparatus. When a cart is used, use caution when moving the cart/ apparatus combination to avoid injury from tip-over.**
- 13. Unplug this apparatus during lightning storms or when unused for long periods of time.**
- 14. Refer all servicing to qualified service personnel. Servicing is required when the apparatus has been damaged in any way, such as power-supply cord or plug is damaged, liquid has been spilled or objects have fallen into the apparatus, the apparatus has been exposed to rain or moisture, does not operate normally, or has been dropped.**



FCC Warning

This equipment may generate or use radio frequency energy. Changes or modifications to this equipment may cause harmful interference unless the modifications are expressly approved in the instruction manual. The user could lose the authority to operate this equipment if an unauthorized change or modification is made.

CE Warning

This is a Class A product. In a domestic environment this may cause radio interference in which case the user may be required to take adequate measures.

The apparatus shall not be exposed to dripping or splashing and no objects filled with liquids, such as vases, shall be placed on the apparatus.

WARNING

Pay attention to the following information before installing the GANZ ZR-DH1621NP.

- Keep the product away from heat. Do not expose the product directly to the sun or heating apparatus. (becomes a fire hazard)
- Do not leave vessels with water such as a vase, a flowerpot, a cup, which may cause fire or electric shock.
- Do not insert or put metallic material (coin, hair pin, metal) or flammable materials (paper, matches) through vent holes.
- Do not place heavy objects on the product.
- Disconnect from power source during a thunder storm.
- Do not use chemicals or detergent to clean the product. Use a dry cloth.
- Discontinue using if there is strange odor or smoke. Power off and call for service.
- Do not touch the power plug with wet hands.
- Do not pull on the power cord.
- Do not twist the power cord. It may cause a fire or electric shock.
- Use an exclusive outlet. (Overloading the outlet may cause a fire or electric shock.)
- Do not expose to rain, extremely humid or dusty environments.
- Do not open the cover of the product.
- Do not place this product on an unstable shelf, cart, stand or tripod. The product may fall, causing serious injury and damage to the product.
- Do not place heavy items on the power cord.
(It may cause a fire or electric shock.)
- Do not use multi outlet with any other devices. (It may cause a fire because the outlet is overloaded.)
- When disconnecting the power plug, do not pull it by the cord. Doing so may damage the cord causing electric shock or fire.
- Power cords should be routed so that they are not likely to be walked on or pinched by items placed upon or against them.
- Do not touch the power adapter or signal processor with wet hand. (It may cause electric shock.)
- This product generates, uses and can radiate radio frequency energy. If not installed and used in accordance with the instruction manual it may cause radio communication interference.
- Do not block any vents. It may cause the fan to stop and damage the product.



Contents

1 Parts and Features	1
1. 1 DVR System and Accessories	1
1. 2 Features	2
1. 3 Parts name and Description	3
2 Setup and Connections	7
2. 1 Power Setup	7
2. 2 Telemetry Connection	7
2. 2. 1 PORT A RS-422	7
2. 2. 2 PORT B RS-422/RS-485	7
2. 3 Alarm Connections	8
2. 3. 1 ALARM INPUT	8
2. 3. 2 ALARM OUTPUT	8
2. 4 External Storage	9
2. 4. 1 Using USB memory device	9
2. 4. 2 Connecting CD-R/RW & HDD via USB	9
2. 4. 3 Connecting IEEE1394 (FireWire) devices	9
2. 5 Connecting to LAN or Internet	9
2. 5. 1 Making physical connection	9
2. 5. 2 Automatic network configuration	9
2. 5. 3 Manually configure network	9
3 Menu Configuration	11
3. 1 Camera Setup	11
3. 1. 1 Channel Setup	11
3. 1. 2 PTZ Model	11
3. 1. 3 Video Format	12
3. 2 Recording Setup	12
3. 2. 1 Schedule	12
3. 2. 2 Specific Dates Schedule	14
3. 2. 3 Manual Recording	14
3. 3 Alarm Setup	15
3. 3. 1 Alarm Outputs	15
3. 3. 2 Event	15
3. 3. 3 Alarm Name	15
3. 3. 4 Alarm Buzzer	15

3. 4 Display Setup	.16
3. 4. 1 User Defined Screen	.16
3. 4. 2 Sequence	.16
3. 4. 3 Spot Monitor	.16
3. 4. 4 Transparency	.17
3. 5 Audio Setup	.17
3. 6 Administration	.17
3. 6. 1 Language	.17
3. 6. 2 HDD Management	.18
3. 6. 3 Network Setup	.19
3. 6. 4 Date/Time Setup	.19
3. 6. 5 Password Administration	.20
Access to the DVR can be controlled b	.20
3. 6. 6 Firmware Management	.21
Firmware is the internal soft	.21
channels are channels	.21
DVR is capable of sending	.21
3. 6. 9 Configuration Management	.22
3. 6. 10 Telemetry Control	.22
3. 6. 11 System Information	.23
3. 7 Backup	.23
3. 8 Event Log	.24
3. 9 Power	.24
3. 10 Lock Front Panel	.24
4 Monitoring and Playback	.25
4. 1 On-Screen Display	.25
4. 2 Playback	.25
4. 3 Search Playback	.25
4. 4 PTZ Mode	.25
4. 4. 1 Controlling PTZ Camera	.25
4. 4. 2 Using PTZ Presets	.25
4. 5 Remote Access	.26
4. 5. 1 Live Page	.26
4. 5. 2 Playback Page	.26
5 Troubleshooting	.27

Appendix A29
Factory Default Menu Settings29
Appendix B30
Recording Rate30
Appendix C31
Recording Time31
Appendix D33
Menu Tree33
Appendix E34
Specifications34



1 Parts and Features

1. 1 DVR System and Accessories

Appearance may vary.



ZR-DH1621NP



Rack Mount Brackets

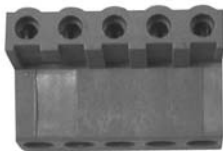

RS-485/422 Terminal Block

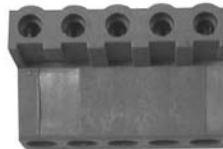

Alarm Out Terminal Block

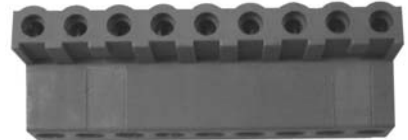

Alarm In (2EA) Terminal Block



CD-ROM



Power Cord



RJ-11 Cable & Terminal Block

1. 2 Features

- 1) High quality digital recording**
Record and playback High-Resolution digital video by using Wavelet compression and decompression circuitry.
- 2) Simple user interface**
Simple operation by telemetry, integrated buttons and jog shuttle/dial.
- 3) High reliability**
Highly reliable due to a combination of hardware quality and an embedded LINUX based operating system.
- 4) Simple setting and system maintenance**
Enables simple installation and operation with basic settings and camera inputs.
- 5) Diverse total security function**
Enables security system by using alarm inputs, outputs and PTZ camera control.
- 6) Remote data backup**
Backup and playback using client application via network.
- 7) Large storage capacity**
Storage can be extended through the use of external IEEE 1394 and USB interfaces.
- 8) Local data backup**
Back up image using USB memory devices such as USB FDD, USB ZIP Drive.
- 9) Diverse monitoring function**
Diverse monitoring is possible such as FULL/PIP/4/6/8/9/13/16/user/ZOOM screen. View live and playback simultaneously while recording.
- 10) Audio recording playback function**
Adjustable audio quality and compression for added flexibility.
- 11) Motion detection and event recording**
Digital motion detection and event recording with pre and post alarm recording.
- 12) Search Function**
Playback quickly via diverse search conditions and event log.
- 13) Firmware upgrade**
Allows easy upgrade of product firmware via the Internet or USB port.
- 14) Various recording resolution**
Record up to 120FPS NTSC or 100FPS PAL and 7 quality levels.
- 15) Simultaneous recording and playback**
True triplex function allows for simultaneous recording and playback locally as well as via the network.
- 16) Multi password function**
Allows 5 permission levels to control access and operation.
- 17) Event Notification function**
Notification via e-mail to monitor alarms as well as various events and actions.
- 18) Camera control function**
Allows PTZ camera control from the built-in front panel keys.

1. 3 Parts name and Description

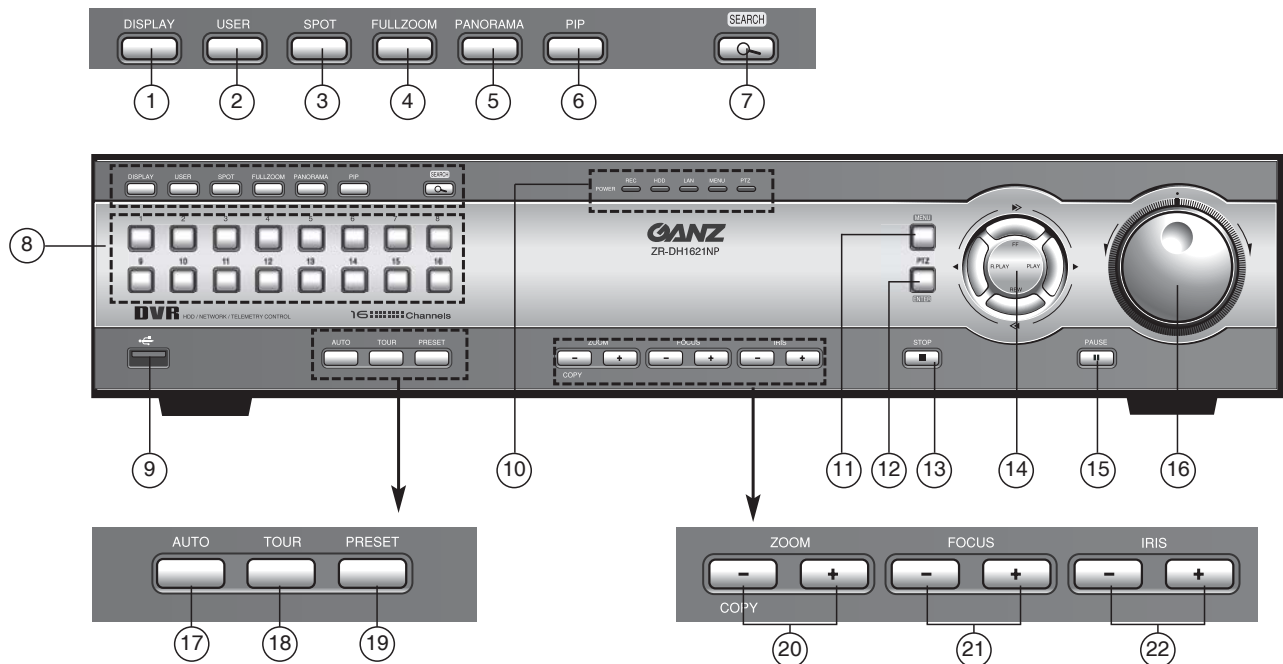

1) DISPLAY

Toggles between 1, 4, 9, 16, 6, 8 and 7 split screens. Enter PTZ on-screen menu in PTZ mode.

2) USER

Enter user defined screen mode. Use the DISPLAY button to toggle between 4, 9, 6, 7, 10, 13, 8 and PIP screens. Enter detail view while in Recording Schedule.

3) SPOT

Enter SPOT mode to allow SPOT monitor control. When enabled the main monitor displays the **Spot** status indicator.

4) FULL ZOOM

Allows 2, 3 or 4 times zooming. Use the directional buttons to move the zoomed area.

5) PANORAMA

Playback a single channel on a multi-split screen. Use the DISPLAY and channel buttons to adjust the viewing effect.

6) PIP

Picture-in-Picture mode allows to view live and playback screens simultaneously.

7) SEARCH

Playback by specific date and time or event.

8) Channels (1~16)

Select video channels in live, playback, PTZ and menu modes. Buttons 1~10 are used to enter password digits.

9) USB port

Used to connect HDD, CD writers and memory devices.

10) LED Indicators

POWER/REC, HDD, LAN, MENU and PTZ indicators.

11) MENU

Enter menu mode; exit sub-menus.

12) PTZ/ENTER

Enter PTZ mode; select or confirm menu selection.

13) STOP

Stops playback; reset alarms; hold down to select multiple cells in Recording Schedule.

14) R.PLAY, PLAY, FF, REW

◀ R.PLAY: Reverse Playback/Left

▶ PLAY: Playback/Right

▶▶ FF: Fast Forward/Up

◀◀ REW: Rewind/Down

Used to control Pan/Tilt



15) PAUSE

Pause playback.

16) Jog Shuttle/Dial

Shuttle: Fast forward or rewind during playback.

Dial: Slow forward/reverse playback in pause.

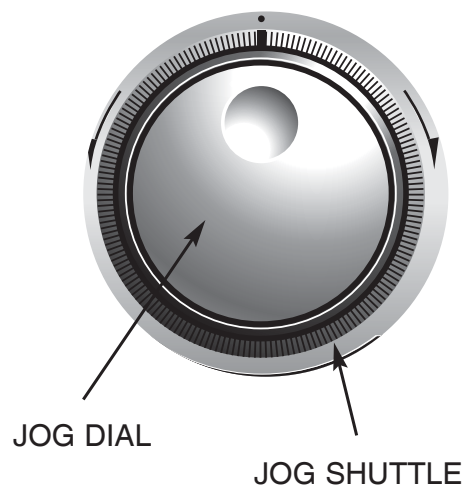

17) AUTO

Sequences channels in live view mode; enables auto focus in PTZ mode.

18) TOUR

Initiate PTZ tour.

19) PRESET

Setup PTZ preset positions.

20) ZOOM/COPY

Adjust zoom position in PTZ mode; copy image to USB device.

21) FOCUS

Adjust focus position in PTZ mode.

22) IRIS

Adjust Iris position in PTZ mode.

REAR

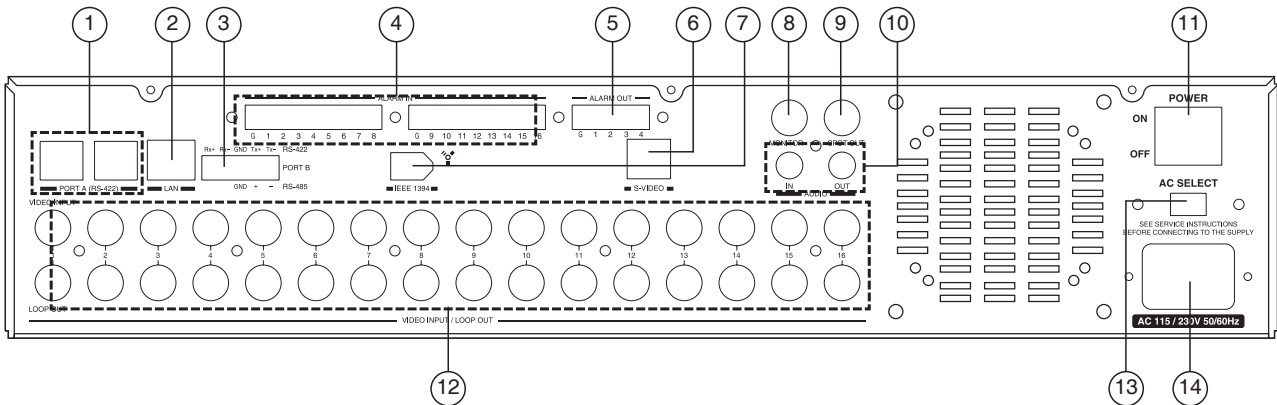

1) PORT A (RS-422)

Used for communicating with external devices in full-duplex RS-422.

2) LAN

10/100 Base-T ethernet connection.

3) PORT B (RS-422/RS-485)

Used for communicating with external devices in full-duplex RS-422 or half-duplex RS-485

4) ALARM IN

16 alarm inputs.

5) ALARM OUT

4 alarm outputs.

6) S-VIDEO

Monitor output as S-VIDEO signal.

7) IEEE 1394

Connect external IEEE 1394 devices (FireWire) such as HDD and CD-RW.

8) MONITOR

Monitor output as composite signal.

9) SPOT OUT

Spot monitor output as composite signal.

10) AUDIO IN/OUT

RCA terminals for audio recording and playback.

11) POWER Switch

Main power switch.

12) VIDEO INPUT & LOOP OUT (1~16)

Connect asynchronous video signal 1.0 Vp-p (75 ohm). Loop out is changed to HI-Z automatically.

13) AC SELECT

Select AC115V or 230V.

14) AC INLET

Input power voltage.

Notice

Connect and power IEEE 1394 devices prior to powering DVR. Some devices may not be recognized when both HDD and CD-R/RW devices are present.



2 Setup and Connections

2. 1 Power Setup

Select power (AC 115V/AC 230V) by AC Selector according to input voltage.

- If set as figure 1, AC 115V is selected.
- If set as figure 2, AC 230V is selected.

Figure 1

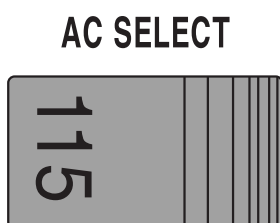
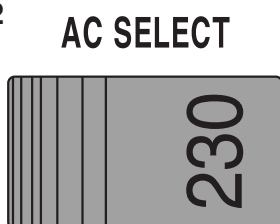

Figure 2



2. 2 Telemetry Connection

Multiple DVRs and keypads may be connected via RS-422 (PORT A). Up to two PTZ serial communication lines are supported via RS-485/422 (PORT A, PORT 1 & PORT 2).

2. 2. 1 PORT A RS-422

There are two RJ-11 connections for PORT A which can be used to "chain" the DVR with other devices. The primary use of PORT A is to interconnect two or more DVRs and/or keypads (optional).

PORT A can also be used to connect PTZ cameras by using the RJ-11 Terminal Block.

Note

Even though there are two physical connections PORT A is a single port designed to connect multiple devices in a single communication line.

2. 2. 2 PORT B RS-422/RS-485

PORT B is a 5-pin terminal connection. It can be used as either a full-duplex RS-422 port or a half-duplex RS-485 port.

Use this port to connect PTZ cameras, DVRs or keypads (optional).

2. 3 Alarm Connections

2. 3. 1 ALARM INPUT

Connect up to 16 alarm sensors using the supplied terminal blocks.

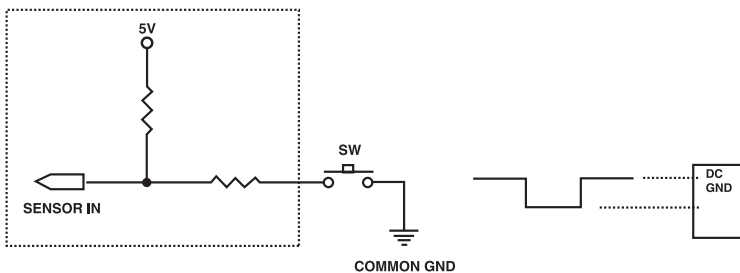
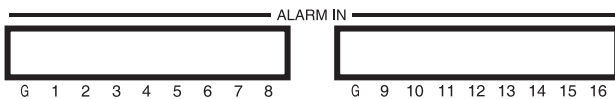
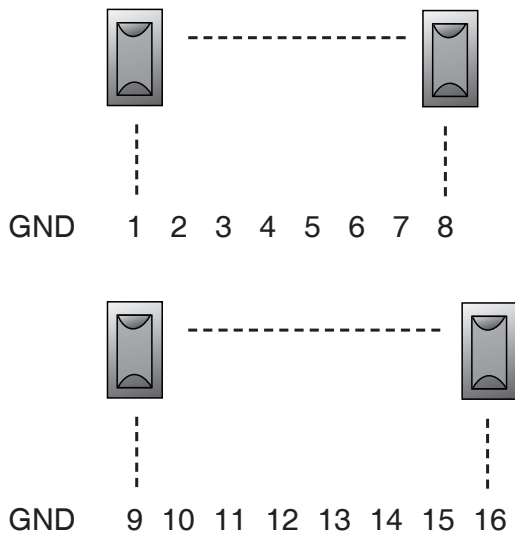

Notice

Each ALARM IN should be connected with GND which is grounded by TTL or contact point. Components z

2. 3. 2 ALARM OUTPUT

Connect up to 4 separate alarms to the Alarm Output.

Alarm may be triggered by numerous events including digital motion detection, Full Disk, Signal Loss, Power Off, Network Access.

The signal state is adjustable to N/O (Normaly Open) or N/C (Normaly Closed).

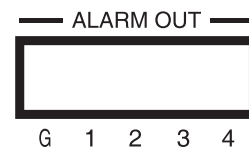
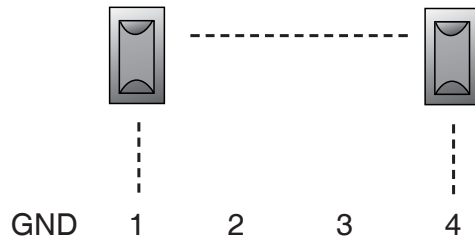

Notice

The internal switching relays are rated for up to 24V at 1.0A maximum. Damage may occur if current is higher!

2. 4 External Storage

2. 4. 1 Using USB memory device

Insert the memory device into the USB port. The system automatically recognizes the device.

2. 4. 2 Connecting CD-R/RW & HDD via USB

Connect and power each USB device before powering the DVR.

2. 4. 3 Connecting IEEE1394 (FireWire) devices

Connect and power each device before powering the DVR.

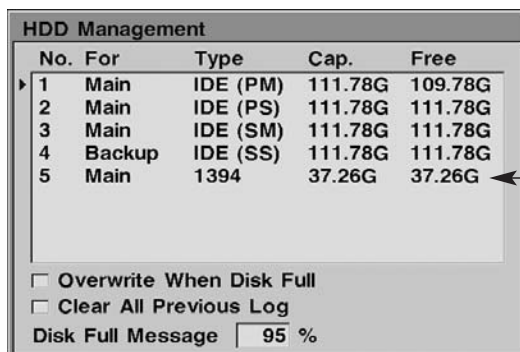

No.	For	Type	Cap.	Free
1	Main	IDE (PM)	111.78G	109.78G
2	Main	IDE (PS)	111.78G	111.78G
3	Main	IDE (SM)	111.78G	111.78G
4	Backup	IDE (SS)	111.78G	111.78G
5	Main	1394	37.26G	37.26G

Overwrite When Disk Full
 Clear All Previous Log
Disk Full Message

FireWire devices appear in HDD Management as type 1394

2. 5 Connecting to LAN or Internet

2. 5. 1 Making physical connection

Connect the LAN port of the DVR to an available 10/100 Base-T port with a straight ethernet cable (not supplied). The link indicator LED will be lit.

2. 5. 2 Automatic network configuration

The DVR can automatically obtain and configure the network interface via DHCP. Refer to page 19.

2. 5. 3 Manually configure network

The DVR may be manually configured by assigning an IP address, subnet mask, gateway DNS. Refer to page 19.

Note

Up to 20 FireWire devices may be connected in series.



3 Menu Configuration

The features and options of the DVR are configured through the menu.

- Use the Jog Dial or directional buttons to navigate through the menu.
- Press ENTER button to select or confirm.
- Press MENU button to return to previous menu.



3. 1 Camera Setup

The video channels, PTZ and video format settings are configured through the Camera Setup menu.

3. 1. 1 Channel Setup

Select the desired channel with the channel button. Each video channel can be adjusted independently.

- **Name**
Enter the Channel name up to 16 characters.
- **Control ID, Reverse Pan, Reverse Tilt**
If this channel is for a PTZ camera enter the camera ID and pan/tilt directions.
- **Model**
If this channel is for a PTZ camera choose the model.

- **Control Test**
Select this button to test the PTZ settings.
- **Adjustment**
Adjust the the brightness, contrast, saturation and hue for this channel

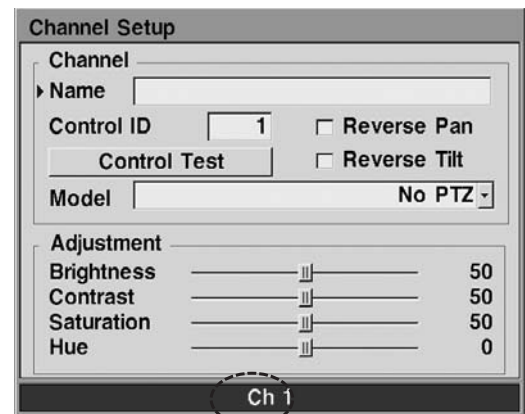

3. 1. 2 PTZ Model

The communication speed of each PTZ model can be adjusted.

- **Select Model**
Choose the PTZ model.
- **Baud Rate**
Choose the communication speed.

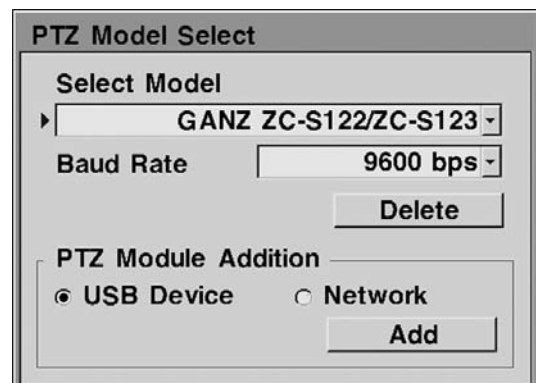

A new PTZ model can be added to the system if the protocol software is available.

An existing PTZ model can be deleted by choosing the model and selecting the Delete button.

3. 1. 3 Video Format

The DVR can support both NTSC and PAL formats. This setting can be changed through the Video Format menu.

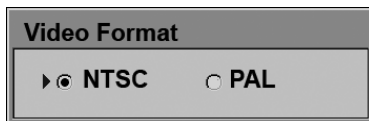

To change the format select either NTSC or PAL and press the MENU button. The system will restart in the chosen format.

Important

Changing the format will initialize the HDD storage and all data will be lost.

3. 2 Recording Setup

The DVR can record according to schedule set by the user. It can also record manually regardless of date and time. This is called Manual Recording.

The recording can be made either continuously or triggered by events (alarm and motion detection).

The recording rate and resolution can be adjusted for each recording defined in the Schedule or Manual Recording.

The DVR is set to record in Schedule mode from the factory with pre-defined schedule. Thus it is always recording.

To stop recording the DVR must be put into Manual Recording mode and recording turned off.

3. 2. 1 Schedule

The Recording Schedule screen displays one day of the week showing the schedule of all channels over a 24-hour period.

For each 1-hour cell block the recording method, rate and resolution can be specified.

The quality level (QL) can be adjusted for each hour. The audio recording (AR) can also be enabled or disabled.

The recording method (Continuous, Alarm, Motion) for each block is shown in color for easy viewing. The recording rate and resolution are not shown. To see the detail settings press the USER button.

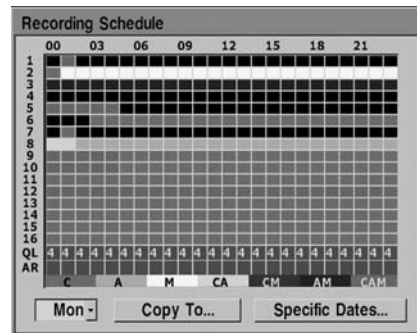

The detail screen shows 8 channels over a 6-hour period. Press the USER button again to return to the summary view.

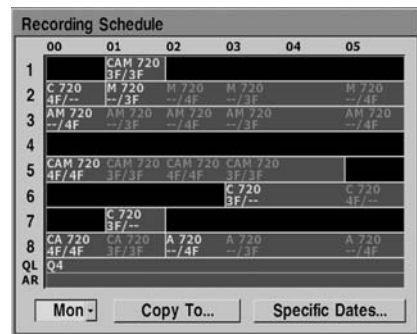

- **To edit one block**
Move the highlighted cell block and press the ENTER button.
- **To edit multiple blocks**
Move the highlighted cell block to one corner of a rectangle area. Press and hold the STOP button then expand the highlighted area as desired. Press the ENTER button.

Recording Event

Continuous Field Rate Max / 1 Sec

Alarm Field Rate Max / 1 Sec

Motion

Recording Resolution 720 ▾

Choose the recording methods, Field Rate and Recording Resolution for the block(s). Two settings can be specified: one for continuous recording, the other for alarm and motion recording.

• **Field Rate**

The available rate depends on the resolution and the number of channels being recorded. For most applications set to Max.

• **Resolution**

Set the horizontal resolution to 720 or 360.

Quality

Low 4 High

The quality level (QL) can be assigned to each hour. The level ranges from 1 (low) to 7 (high). Low quality setting results in high compression which takes less storage space. High quality setting retains more detail with lower compression but takes up more space.

Quality Level	Image File Size (KB)	
	720	360
Q7	18	11
Q6	17	10
Q5	15	9
Q4	13	8
Q3	10	6
Q2	7	5
Q1	5	3

Note

The image file size shown is average. The actual size may vary.

To view and setup another day of the week select the desired day as shown and press the ENTER button.

Recording Schedule

	00	01	02	03	04	05
1		CAM 720 3F/3F				
2	C 720 4F/--	M 720 --/3F	M 720 --/4F	M 720 --/3F	M 720 --/4F	M 720 --/4F
3	AM 720 --/4F	AM 720 --/3F	AM 720 --/4F	AM 720 --/3F	AM 720 --/4F	AM 720 --/4F
4						
5	CAM 720 4F/4F	CAM 720 3F/3F	CAM 720 4F/4F	CAM 720 3F/3F		
6				C 720 3F/--		C 720 4F/--
7	Mon	C 720 3F/--				
8	Tue					
9	Wed	CA 720 3F/3F	A 720 --/4F	A 720 --/3F	A 720 --/4F	A 720 --/4F
10	Thu					
11	Fri					
12	Sat					
13	Sun					

Copy To... Specific Dates...

The copy function within the Schedule allows copying the setting from one channel to others. Once the recording schedule for an entire day is complete it can be copied to other days. To copy the channel or the day select the Copy To button.

Copy Schedule

Days
 Copy

Channel
Source Channel 1 ▾

2	3	4	5	6	7	8	
9	10	11	12	13	14	15	16

Copy

To copy days select the day(s) of the week and select the Copy button. For channels select the source channel, select the channel(s) to be copied then select the Copy button.

3. 2. 2 Specific Dates Schedule

In addition to the weekly schedule, up to 16 specific date/time periods can be defined. To configure the specific recording schedule select Specific Dates.

	2004/01/01-00:00	2004/11/04-00:00	
2	2004/01/01-23:59	2004/11/08-23:59	Add
1	C 720 3F/--	C 720 3F/--	
2	C 720 3F/--	C 720 3F/--	
3	C 720 3F/--	C 720 3F/--	
4	C 720 3F/--	C 720 3F/--	
5	C 720 3F/--	C 720 3F/--	
6	C 720 3F/--	C 720 3F/--	
7	C 720 3F/--	C 720 3F/--	
8	C 720 3F/--	C 720 3F/--	
9	C 720 3F/--	C 720 3F/--	
10	C 720 3F/--	C 720 3F/--	
11	C 720 3F/--	C 720 3F/--	
12	C 720 3F/--	C 720 3F/--	
13	C 720 3F/--	C 720 3F/--	
14	C 720 3F/--	C 720 3F/--	
15	C 720 3F/--	C 720 3F/--	
16	C 720 3F/--	C 720 3F/--	
QA	Q4	Q4	
	Disable	Delete	Enable Delete

- **Add New Schedule**

With the "Add" highlighted press the ENTER button. Enable the schedule and Specify the date/time period. Press the MENU button when finished.

Enable	<input type="checkbox"/>
Start Recording	
Date	2004. 01. 01
Time	00h 00m
End Recording	
Date	2004. 01. 01
Time	23h 59m

- **Change Schedule**

Define the recording setting for each channel as well as the quality level and audio.

- **Delete Schedule**

Highlight the "Delete" and press the ENTER button.

3. 2. 3 Manual Recording

Use the Manual Recording method when the recording does not depend on a schedule (dates, days and time). To setup manual recording, select Manual as the Record Mode.

Schedule
Manual Recording
Record Mode
<input type="radio"/> Schedule <input checked="" type="radio"/> Manual
<input checked="" type="checkbox"/> Manual Record On

Then define the record settings for each channel within the Manual Recording screen.

1	C	720	4F/--
2	AM	720	--/4F
3			
4	CAM	720	4F/4F
5			
6	A	720	--/4F
7	M	720	--/4F
8	C	360	4F/--
9	CAM	720	4F/4F
10	CAM	360	4F/4F
11	C	720	1F/--
12	CAM	720	4F/4F
13			
14	A	720	--/4F
15	CAM	720	4F/4F
16	C	720	4F/--
QA		Q4	

3. 3 Alarm Setup

Within the Alarm Setup menu, alarm conditions and events, as well as digital motion detection settings are defined.

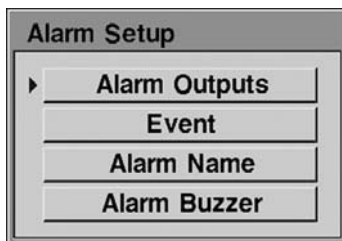

3. 3. 1 Alarm Outputs

There are four alarm outputs. For each output, define the alarm inputs and conditions.

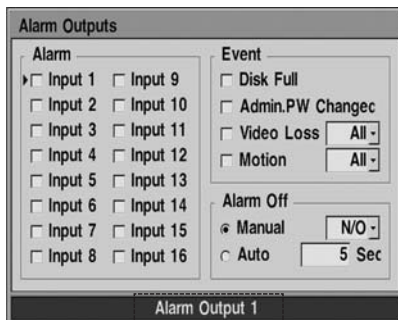

- **Alarm**
Select the alarm input(s) to trigger this alarm output.
- **Event**
Select events to trigger this alarm output.
- **Alarm Off**
Choose the way the alarm is reset. The alarm can be reset automatically by selecting Automatic and specifying the time in seconds. If it is set to Manual the user must press the STOP button.

The alarm state can be set to either N/O (Normally Open) or N/C (Normally Closed).

3. 3. 2 Event

Pre- and post-alarm recording can be defined in seconds.

- **Pre-Recording Time**
Specify the time in 0 ~ 20 seconds.
- **Post-Recording Time**
Specify the time in 0 ~ 99 seconds.

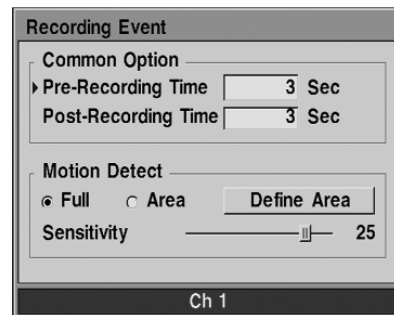

For each channel, motion detection area and sensitivity can be setup. Press the desired channel button and define the settings.

- **Full**
Entire video screen is subject to motion detection.
- **Area**
Motion is detected only in the area specified.
- **Sensitivity**
Specify the motion sensitivity (1 ~ 30). Higher the value, more sensitive the motion detection is.
- **Area Define**
Select the motion sensing areas by highlighting the 14 x 14 grid screen.
Use the directional buttons and press the ENTER button.

3. 3. 3 Alarm Name

The alarm inputs can be named. Select the alarm input and enter its name.

3. 3. 4 Alarm Buzzer

If enabled, when an alarm is triggered by the alarm input or motion detection a buzzer will sound. It can automatically clear after a specified time.

3. 4 Display Setup

3. 4. 1 User Defined Screen

In addition to the pre-defined screens, the channels can be arranged to the user's preference in the 8 variations of multi-screen views. This is very convenient when used with the AUTO sequencing function.

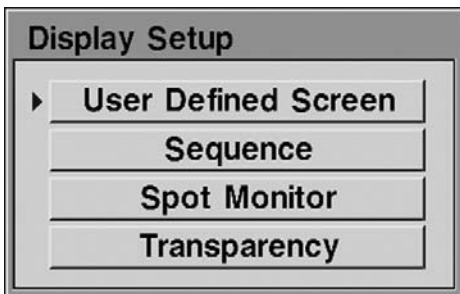

Select the desired multi-screen view (1-8) using the left/right directional keys. Then use the Jog Dial to highlight each screen and assign a channel with channel buttons.

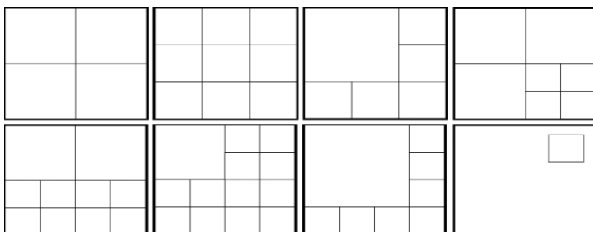
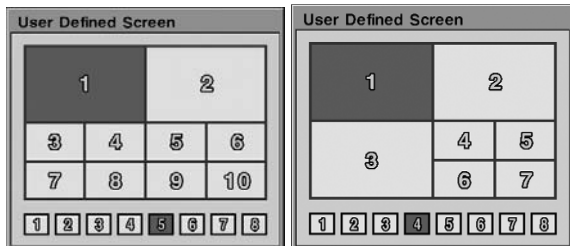

3. 4. 2 Sequence

Live channels and multi-screen channels can be sequenced automatically according to the interval defined in seconds. Channels can be excluded from sequencing.

- **Interval**
Enter the sequence interval in 0 ~ 300 seconds.
- **Channel Selection**
Select the channels to sequence.
- **Skip Video Loss Channel**
Channels with no video input are excluded from sequencing.
- **Alarm Sequence**
During alarm condition the live view sequences among the channels with alarm.

3. 4. 3 Spot Monitor

The spot monitor can be configured in several ways.

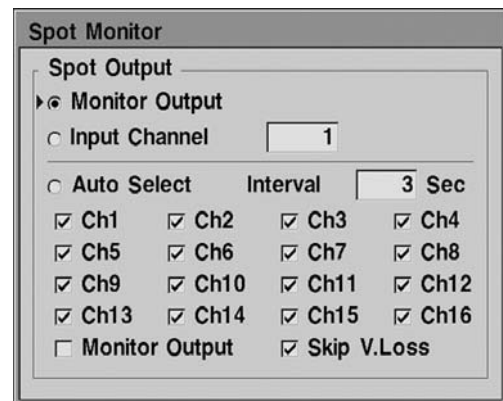

- **Monitor Output**
Displays the same image as the MONITOR output.
- **Input Channel**
Displays a specific channel.
- **Auto Select**
Select the channels to sequence and specify the interval.

3. 4. 4 Transparency

The on-screen display can be made transparent from 0 ~ 80% so the images are not covered or blocked by the on-screen status or menu.

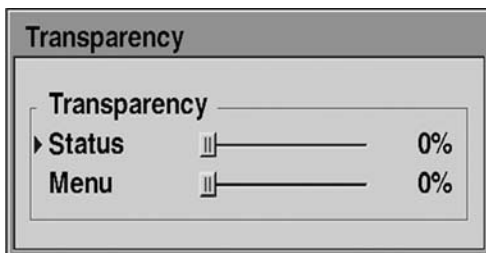

3. 5 Audio Setup

The DVR can record and playback one of audio channel audio.

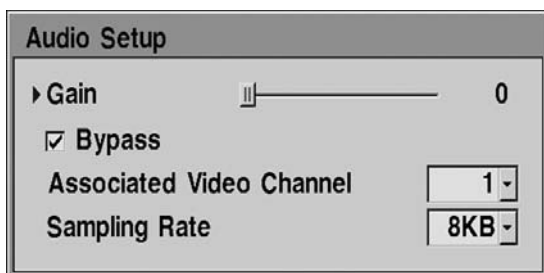

- **Gain**
Select the gain from 0 ~ 5.
- **Bypass**
In Live view audio is passed through to AUDIO OUT
- **Associated Video Channel**
Specify which channel will play audio during playback.
- **Sampling Rate**
Audio sampling rate can be adjusted to either 8KB (8KHz) or 12KB (12KHz).

3. 6 Administration

Various administrative settings and DVR features can be accessed through the Administration menu. Access to this menu should be restricted by the use of a password.

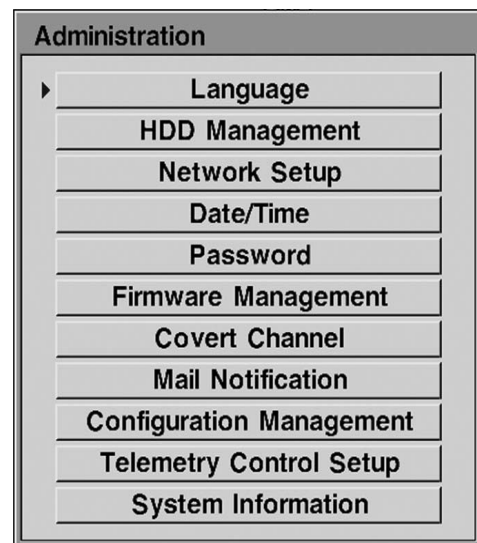

3. 6. 1 Language

Menu and on-screen language can be changed by selecting the desired language. The menu will immediately change to the selected language.

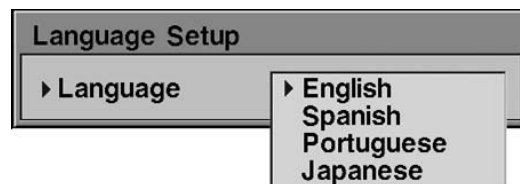

Available languages are English, Spanish, French, Spanish, German, Italian, Polish, Portuguese, Russian, and Japanese.

3. 6. 2 HDD Management

Both internal and external HDD storage devices can be managed through the HDD Management screen. The DVR can support 4 internal HDD drives and up to 20 external IEEE1394 devices.

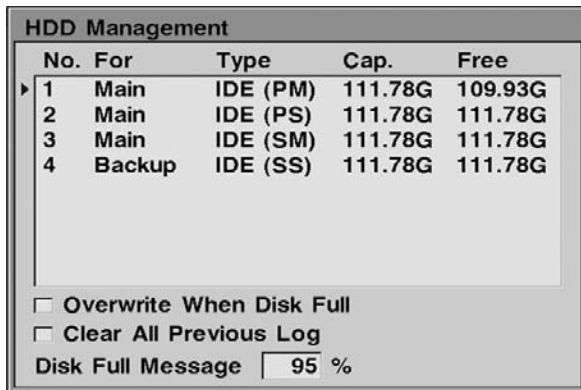

All drives detected by the system are listed with type, capacity and remaining free space. Each drive can be assigned as MAIN or Backup. However only one drive can be assigned as Backup.

Note

The HDD Management screen will also be displayed when any new storage device is detected upon power on. The newly detected devices should be setup and initialized prior to use.

To change the assignment select the drive and press the ENTER button.

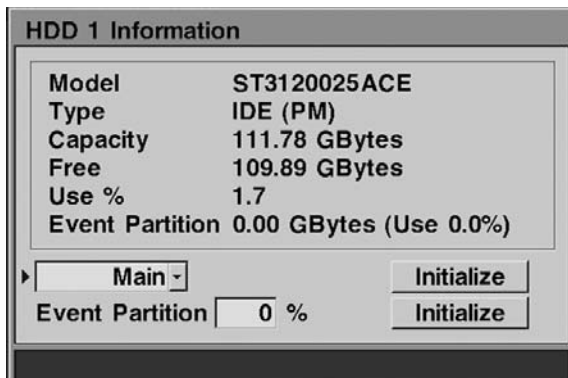

- **Initialize**

The drive can be initialized. All information on the selected drive and below it are erased.

- **Indicate**

IEEE1394 devices can be identified by selecting the Indicate button. LED on the device will flash.

- **Event Partition**

On the first internal drive, type IDE (PM), a separate partition can be created to store and preserve recording events. The information in the alarm event is never overwritten. Specify the size (0-90%) to create the partition.

- **Overwrite when Disk Full**

Enabling this option will allow the DVR to overwrite starting with the oldest images when there is no more free storage space. When disabled the on-screen display shows the percentage of storage used.

- **Clear All Previous Log**

All log information stored in the drives is erased.

- **Disk Full Message**

Specify when the “HDD is Almost Full” warning message is displayed.



3. 6. 3 Network Setup

The DVR can be connected to a TCP/IP network to leverage the features which depend on network connection.

Physically connect the DVR to the local network (LAN) using a straight ethernet cable.

Network Setup

DHCP

Static IP ▶ 0. 0. 0. 0

Subnet Mask 0. 0. 0. 0

Gateway 0. 0. 0. 0

DNS Server 1 0. 0. 0. 0

DNS Server 2 0. 0. 0. 0

Web Server Port Number 80

Apply

- **DHCP**

DHCP is a protocol used to automatically configure the network settings of the DVR. If a DHCP service is available, choose DHCP and select the Apply button. Ask the network administrator for more detail.

- **Static IP**

If DHCP is not available or to manually configure the DVR, enter the IP address, Subnet Mask, Gateway and at least one DNS Server. Then select the Apply button. If not known the network administrator can supply this information.

- **Web Server Port Number**

The DVR can be viewed over the network with a web browser. Typically the TCP port used by HTTP is 80. However in some cases it is better to change this port number for added flexibility or security. If desired change the port number. Valid number is 80 ~ 19999.

3. 6. 4 Date/Time Setup

Keeping the correct date and time is critical in DVR operation. While the date and time can be set manually, it is far better to keep the time synchronized automatically with a time server on the network.

Date/Time Setup

System Time

▶ Date 07. 27. 2004

Time 16h 52m 57s

Date Display

y/m/d m/d/y d/m/y

Time Server Setup

Daylight Saving

07/27/2004-16:53:13

- **System Time**

Enter the correct date and time manually.

- **Date Display**

Choose the correct date format according to the locale.

To automatically set the date and time select Time Server Setup. Then configure the time server and the local time zone. The DVR must be connected to the network in order to use this feature.

Time Server Setup

▶ Use Time Server Use Clock Adjust

Master Master ▾

Time Server

Public Time Server

Private Time Server ntp.nasa.gov

Time Zone GMT ▾

Synchronize every 1 minute interval

Test NTP

- **Use Time Server**

Select this option for automatic time synchronization to occur over the TCP/IP network using the Time Server (SNTP).

- **Master**

Select this option if the DVR will act as the time server for other DVRs on the TCP/IP network.

- **Use Clock Adjust**

Select this option for automatic time synchronization via PORT A (RS-422). Then choose whether this DVR will act as the master or slave.

- **Time Server**

Choose either public or private time server. For most cases select public. The DVR will obtain the average time among 5 public servers (rime.nist.gov, time-a.nist.gov, time-b.nist.gov, ntp.nasa.gov and clock.isc.org). Then specify how often the time is synchronized in minutes. If there is a specific time server then select private and enter its host name or IP address.

- **Time Zone**

Select the time zone for the locale.

- **Daylight Savings**

Specify whether to use daylight saving time and the time period.

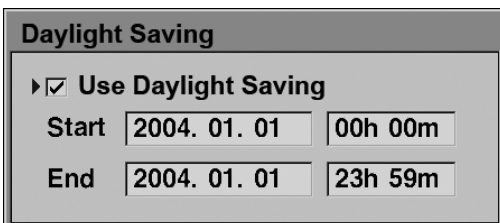

Daylight Saving

Use Daylight Saving

Start: 2004. 01. 01 00h 00m

End: 2004. 01. 01 23h 59m

3. 6. 5 Password Administration

Access to the DVR can be controlled by setting up administrator and user passwords. One or more permissions can be assigned to each user depending on user tasks. Users and passwords can be setup for accessing the DVR at the front panel as well as over the network.



Password Administration

Use Password Web Password

Administrator

New Password:

Confirm:

User ID	Backup	Setup	PTZ	REC	PB
User1		✓	✓		✓
User2	✓		✓	✓	

Add Delete Property...

- **Use Password**

Select this option to enable password. Enter the password for Administrator using the channel buttons 1 ~ 10.

After enabling the password for the first time a unique Master Password is displayed. It is used in case the Administrator password is lost. **Record this key as it is displayed only once.**



Master Password

Remember this key
"73178168"

OK

Additional users can be managed by adding, deleting or changing the permission property of each User ID.

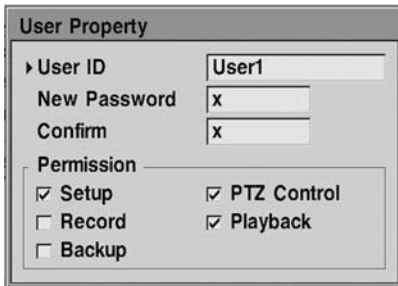

The 'User Property' dialog box contains the following fields and options:

- User ID: User1
- New Password: x
- Confirm: x
- Permission section with checkboxes:
 - Setup
 - Record
 - Backup
 - PTZ Control
 - Playback

3. 6. 6 Firmware Management

Firmware is the internal software of the DVR. This software can be saved or updated. Firmware updates may be necessary to improve the DVR functions. New features may also be added by updating the firmware. The current firmware in the DVR can be saved onto a USB device in case it is needed after the update. It is recommended to save the current version prior to updating the firmware.

New firmware may be available through the dealer, distributor or via the GANZ web site. It may also be readily available to the DVR over the network.

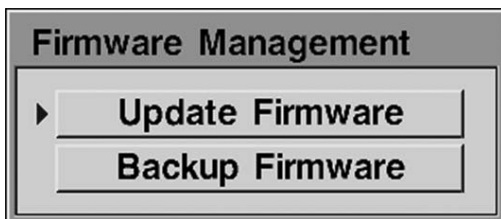

The 'Firmware Management' dialog box features two main buttons:

- Update Firmware
- Backup Firmware

3. 6. 7 Covert Channel

Covert channels are channels which are hidden, and appear to have no video input (video loss). Each channel can be set as covert for live, playback and network viewing.

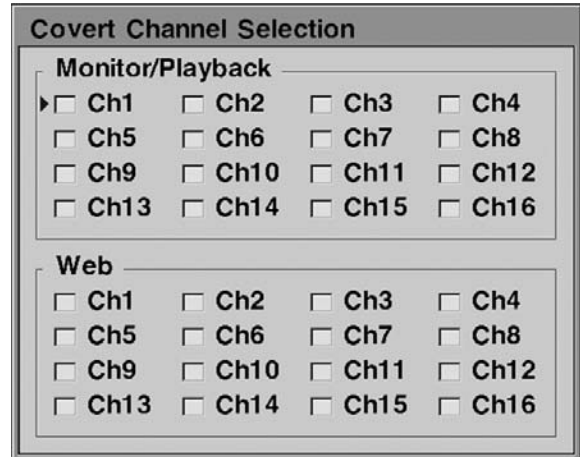

The 'Covert Channel Selection' dialog box is divided into two sections:

- Monitor/Playback:** A grid of checkboxes for channels Ch1 through Ch16. Ch1 is selected.
- Web:** A grid of checkboxes for channels Ch1 through Ch16. No channels are selected.

3. 6. 8 Mail Notification

The DVR is capable of sending event notifications to one or more e-mail addresses.

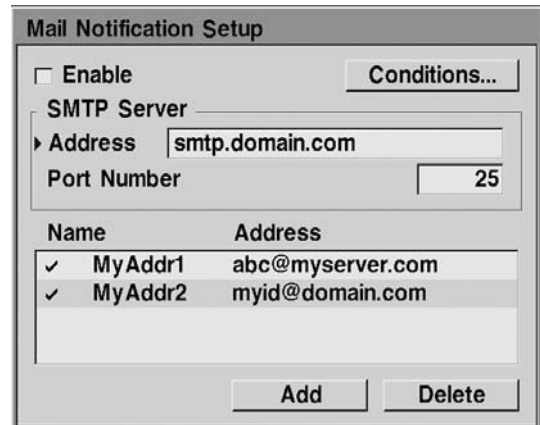

The 'Mail Notification Setup' dialog box includes the following elements:

- Enable (with a 'Conditions...' button next to it)
- SMTP Server section:
 - Address: smtp.domain.com
 - Port Number: 25
- Table of email addresses:

Name	Address
<input checked="" type="checkbox"/> MyAddr1	abc@myserver.com
<input checked="" type="checkbox"/> MyAddr2	myid@domain.com
- Buttons: Add, Delete

- **Enable**
Enable the mail notification.

- SMTP Server, Address, Port Number**
 This setting is optional. The DVR can send e-mail directly without the use of SMTP server or MTA (message transfer agent). In certain cases all e-mail should be forwarded to a specific SMTP server. Specify the server host name or IP address in such case. The port number for SMTP is 25 and does not need to be changed. Setup and manage e-mail addresses by selecting Add, Delete or already defined address. Enter the Name up to 8 characters, Address up to 32 characters in length.



Mail Address

Use

Name

Address

- Events, Conditions**
 Select the events to be notified. Conditions for sending e-mail can be defined by a time period and trigger interval. E-mail can also be triggered by the number of accumulated events.

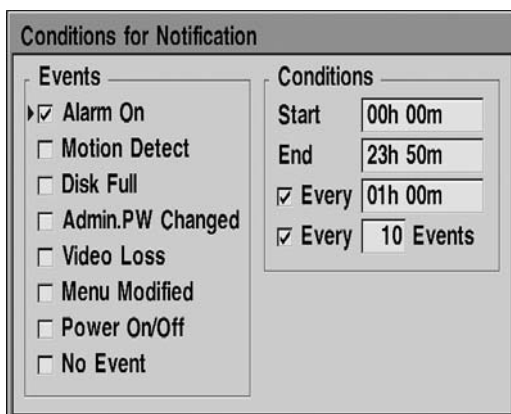

Conditions for Notification

Events	Conditions
<input checked="" type="checkbox"/> Alarm On	Start <input type="text" value="00h 00m"/>
<input type="checkbox"/> Motion Detect	End <input type="text" value="23h 50m"/>
<input type="checkbox"/> Disk Full	<input checked="" type="checkbox"/> Every <input type="text" value="01h 00m"/>
<input type="checkbox"/> Admin.PW Changed	<input checked="" type="checkbox"/> Every <input type="text" value="10 Events"/>
<input type="checkbox"/> Video Loss	
<input type="checkbox"/> Menu Modified	
<input type="checkbox"/> Power On/Off	
<input type="checkbox"/> No Event	

3. 6. 9 Configuration Management

The DVR configurations and all setup definitions can be managed through the Configuration Management menu.

Customized DVR configuration can be saved to a USB device. This backup can restore the DVR when its settings are lost or changed by accident. The backup can also be used to setup multiple DVRs with the same configuration.

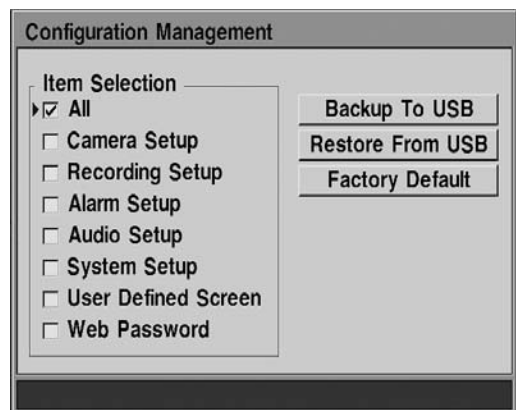

Configuration Management

Item Selection

- All
- Camera Setup
- Recording Setup
- Alarm Setup
- Audio Setup
- System Setup
- User Defined Screen
- Web Password

Backup To USB

Restore From USB

Factory Default

- Item Selection**
 Select the configuration items to backup.
- Backup To USB**
 Selected items are saved to the USB device.
- Restore From USB**
 Saved configuration settings are restore from the USB device.
- Factory Default**
 Reset the DVR to the factory default settings.

3. 6. 10 Telemetry Control

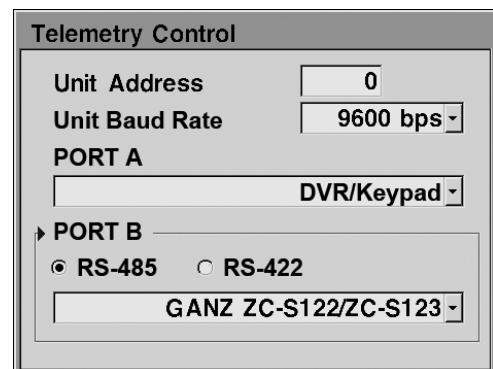

Telemetry Control

Unit Address

Unit Baud Rate

PORT A

PORT B

RS-485 RS-422

- **Unit ID**

When multiple DVRs are connected, assign an ID to each DVR. The Unit ID can be 1 ~ 255.

- **Unit Baud Rate**

Select the DVR communication speed.

- **PORT A, PORT 1, PORT 2**

Select either DVR/keypad or one of the PTZ protocol. PORT 2 can be disabled.

3. 6. 11 System Information

Displays the current software and BIOS versions.



3. 7 Backup

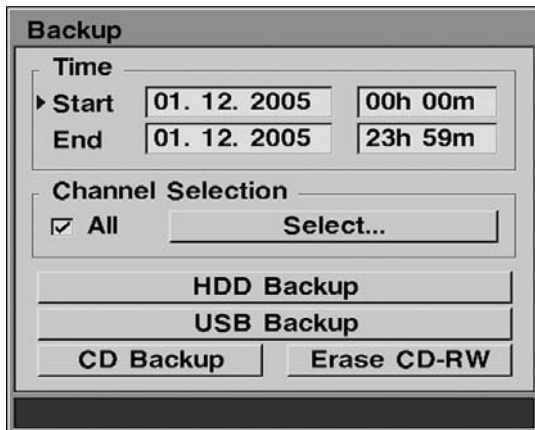

The information stored on the MAIN HDD drives can be copied for archiving. The backup can be made to the Backup HDD drive, USB device or CD-R/RW drive.

- **Time**

Define the start and end date/time.

- **Channel Selection**

Select the channels to archive.

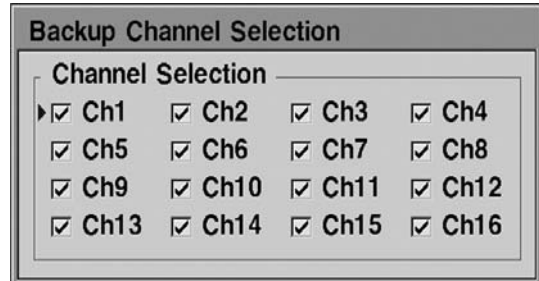

- **HDD Backup**

Specified information is copied to the Backup HDD drive defined in HDD Management.

- **USB Backup**

Specified information is copied to the USB device defined in HDD Management.

- **CD Backup**

Specified information is copied to the CD-R/RW drive.

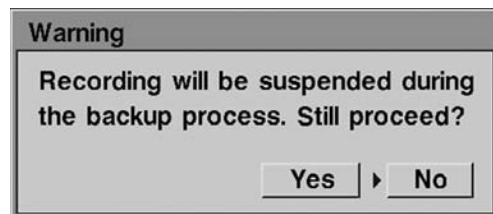

Note

Recording is interrupted during the CD Backup operation. CD Backup is possible only with IEEE 1394 CD-R/RW devices.

- **Erase CD-RW**

Select this option to erase CD-RW media.

3. 8 Event Log

The DVR keeps the log of all events it detects. The log can be filtered and displayed through the Event Log screen. Specify the start date and filter options then select Display. Some events such as alarm and motion detection can be reviewed by selecting and pressing the ENTER button. The DVR will playback the recorded event. To stop playback press the STOP button.



3. 9 Power

The DVR can be powered off or restarted through the Power menu.

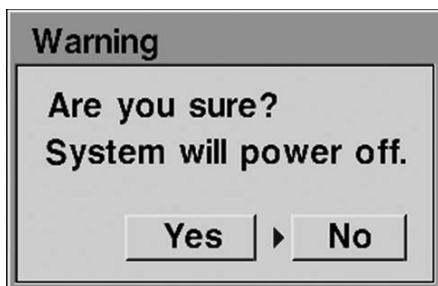

To power off the DVR select the Off button.
To restart the DVR select the Restart button.

Note

To power the DVR on after powering off, turn the rear power switch to the off position for about 3 seconds and then turn it on again.

3. 10 Lock Front Panel

The front panel buttons can be disabled to secure the DVR. To protect from unauthorized use, enable this feature in conjunction with the use of password.

Important

Once locked in this manner, only a user with administrative access may unlock the DVR.

4 Monitoring and Playback

4. 1 On-Screen Display

Each channel is indicated either by its channel name or by the channel number. The date and time is displayed at the bottom of the monitor screen. In live view mode the recording status may also be displayed for each channel.

- Red “**C**” indicates continuous recording.
- Green “**A**” indicates alarm triggered recording.
- Green “**M**” indicates digital motion detection recording.
- No status mark indicates the channel is not being recorded.
- **V.Loss** indicates no video input or the channel is set as covert.

4. 2 Playback

The DVR allows playback at any time even while recording. To playback the recording, press the PLAY button. To stop the playback, press the STOP button. Subsequent playback will start from the point the last playback was stopped.

Use the directional buttons or Jog Shuttle to change the speed and direction of the playback. To playback in slow speed, pause the playback first.

4. 3 Search Playback

Press the SEARCH button to enter the Search feature. Specify the date/time or choose to playback from the Backup HDD or CD. Recording events can also be displayed by selecting Recording Event List.

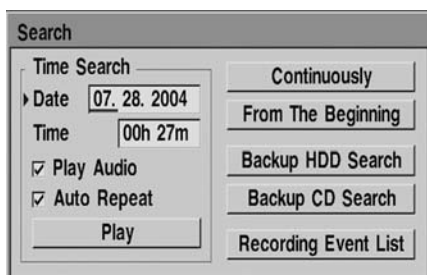

4. 4 PTZ Mode

To control the camera via the front panel, enable PTZ mode by pressing the PTZ button. The main monitor displays the **PTZ** status indicator.

4. 4. 1 Controlling PTZ Camera

Choose the desired PTZ camera using the channel button. Use the Zoom, Focus, Iris and directional buttons to control.

On some PTZ cameras it is possible to manipulate the camera's on-screen menu by pressing the DISPLAY button while in the PTZ mode. Use the directional buttons to navigate through the camera's menu.

4. 4. 2 Using PTZ Presets

To define a preset camera position press the PRESET button and choose the position with the directional buttons. Then select SET followed by the Fast Forward/Up button. When finished press the PRESET button to end.



To manually move the camera to a preset position, first choose the defined preset position and then select MOVE followed by the Fast Forward/Up button. The camera will change its position immediately.

Once the preset positions are setup use the TOUR button to activate the PTZ movement.

4. 5 Remote Access

Remote viewing and playback is possible. The DVR can be viewed over the network with a standard web browser. On the browser address bar, type the IP address of the DVR or its DNS resolvable name. Ask a network administrator for detail.



4. 5. 1 Live Page

Live viewing is possible in 1, 4, 9 or 16-split screen. PTZ camera control is also possible using the zoom, focus and directional buttons on the page.



4. 5. 2 Playback Page

To playback click the PLAY icon from the live page. Specify the date and time and press the “go” button. Change the channel by selecting the channel buttons. To return to the live page click the LIVE icon.

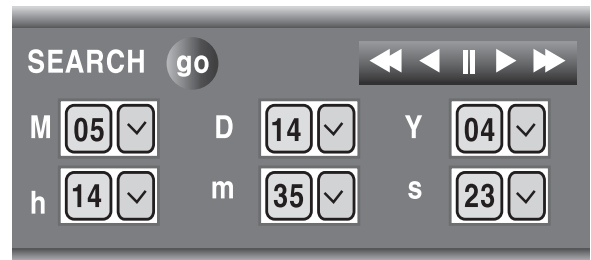

5 Troubleshooting

Symptoms	Resolution
No power.	- Check power connection to DVR
No Front Panel LED activity.	- Check position of 115V / 230V switch
No Monitor Output.	- Check and/or replace fuse - Check position of On/Off switch. - Power device on
Normal Front Panel LED activity.	- Check power connections to monitor
No Monitor Output.	- Check all BNC connections to monitor
Video Loss on a specific channel.	- Check power connection to video source - Check BNC connection from video source to DVR - Make sure channel is not set as 'covert channel'
Menu screen does not appear. when the Menu button is pressed.	- Look at status icons - Make sure device is not in Playback Mode - Make sure you're viewing the main monitor, not spot - Make sure device is not in PTZ mode
No PTZ Function.	- Make sure device is not in Playback Mode
Device will not enter PTZ mode.	- Make sure device is in PTZ mode
No control of PTZ camera in PTZ mode.	- Check serial connections from video source to DVR - Make sure PTZ device is a supported device - Make sure PTZ device is properly configured
No DVR response to front panel buttons.	- Make sure Front Panel is not locked - If locked, enter Administrator Password to unlock.
No External Alarm Control.	- Check all external alarm connections
No input activity from external alarm.	- Make sure external alarm connections are properly configured, using the Alarm Setup menu
No activation of external alarm triggers.	- Make sure that you have correctly specified circuit to be N/O (Normally Open) or N/C (Normally Closed)

Symptoms	Resolution
No playback of audio with video.	<ul style="list-style-type: none"> - Check all audio in/out connections to DVR - Make sure audio is activated and configured - Make sure audio is associated with an active video channel
No firmware upgrade.	<ul style="list-style-type: none"> - Check that new firmware version is correct
Firmware upgrade failed.	<ul style="list-style-type: none"> - Check that USB FDD or ZIP Drive has correct file
Network firmware upgrade failed.	<ul style="list-style-type: none"> - Check network connection; check Internet gateway
No network connectivity	<ul style="list-style-type: none"> - Check network connection to LAN and DVR
No remote control over network	<ul style="list-style-type: none"> - Make sure network configuration is correct
No time server function	<ul style="list-style-type: none"> - Make sure all configured IP addresses are correct
No firmware upgrade over network	<ul style="list-style-type: none"> - Make sure the network access password is correct - Make sure network has gateway to the Internet
No time server function	<ul style="list-style-type: none"> - Check network connection to LAN and DVR - Make sure network configuration is correct - Make sure time server setting correctly specified - Make sure network has gateway to the Internet - If private time server is not available try public servers
No E-mail Notification of alarm condition	<ul style="list-style-type: none"> - Make sure that all alarm conditions are set properly - Check network connection to LAN and DVR - Make sure network configuration is correct - Make sure that e-mail notification settings are correct
Lost Administrator password	<ul style="list-style-type: none"> - Recover lost Admin Password using Master Password
Lost Web Access password	<ul style="list-style-type: none"> - Recover lost Web Password by changing it locally
Lost Master password	<ul style="list-style-type: none"> - Cannot recover lost Master Password Contact service

Appendix A

Factory Default Menu Settings

Design and specifications are subject to change without notice.

Camera Setup

Channel Name: no setup
Brightness: 50
Contrast: 50
Saturation: 50
Hue: 0
PTZ Model: No PTZ
PTZ Baud Rate: 9600

Recording Setup

Schedule: Continuous for all channels
Manual Recording: Continuous for all channels
Record Mode: Manual
Manual Record On: off
Schedule: CH1

Alarm Setup

Alarm Output: no setup
Alarm Name: no setup
Alarm Name: no setup
Alarm Buzzer: enabled
Pre-Recording Time : Middle
Post-Recording Time : 3 Sec
Motion Detect Sensitivity: 25

Display Setup

User Defined Screen: Orderly setup starting with No.1 Ch.
Auto Select Interval: 3 Sec
Spot Monitor: CH1
Transparency Status: 0%
Transparency Menu: 0%

Audio Setup

Gain: 5
Bypass: enabled
Sampling Rate: 8KHz
Associated Video Channel: CH1

Network Setup

Static IP: 192.168.0.1
Subnet Mask: 255.255.255.0
Gateway: 192.168.0.1
DNS Server 1: 192.168.0.1
DNS Server 2: 127.0.0.1
Web Server Port Number: 80

System Setup

Language: English
Admin Password: 1234

Date/Time Setup

System Time: Setup current time
Date Display: m/d/y
No Time Server used

Appendix B

Recording Rate

Based on the number of video inputs and the horizontal resolution, the maximum recording rate will be adjusted automatically. As the number of channels being recorded is changed the maximum recording field/second is limited as in the table below. Lower recording rate can be selected for each channel individually.

Horizontal Resolution 360

Number of Recorded Channels	NTSC	PAL
1 ~ 4	30	25
5 ~ 8	15	12
9 ~ 12	10	8
13 ~ 16	7	6

Horizontal Resolution 720

Number of Recorded Channels	NTSC	PAL
1 ~ 2	30	25
3 ~ 4	15	12
5 ~ 6	10	8
7 ~ 8	7	6
9 ~ 10	6	5
11 ~ 12	5	4
13 ~ 14	4	3
15 ~ 16	3	3

Appendix C

Recording Time

The table below shows the recording time in hours based on standardized general video signal. There may be a difference depending on the contents of the video input, motion and noise level.

HDD: 250GB
Resolution: 720 x 240
Video: 16 Channels
Audio: 8KB sampling rate

Quality \ FPS	3F/1S	2F/1S	1F/1S	1F/2S	1F/3S	1F/4S	1F/5S	1F/6S	1F/8S	1F/16S
Q7	68	102	203	407	610	814	1017	1221	1628	3255
Q6	79	119	237	475	712	949	1187	1424	1899	3798
Q5	90	136	271	543	814	1085	1356	1628	2170	4340
Q4	102	153	305	610	916	1221	1526	1831	2441	4883
Q3	136	203	407	814	1221	1628	2035	2441	3255	6510
Q2	192	288	576	1153	1729	2306	2882	3459	4612	9223
Q1	271	407	814	1628	2441	3255	4069	4883	6510	13021

(Unit: Hour)

HDD: 250GB
Resolution: 720 x 240
Video: 16 Channels
Audio: none

Quality \ FPS	3F/1S	2F/1S	1F/1S	1F/2S	1F/3S	1F/4S	1F/5S	1F/6S	1F/8S	1F/16S
Q7	78	117	235	473	710	947	1184	1421	1896	3795
Q6	79	119	237	475	712	949	1187	1424	1899	3798
Q5	90	136	271	543	814	1085	1356	1628	2170	4340
Q4	102	153	305	610	916	1221	1526	1831	2441	4883
Q3	136	203	407	814	1221	1628	2035	2441	3255	6510
Q2	203	305	610	1221	1831	2441	3052	3662	4883	9766
Q1	283	424	848	1695	2543	3391	4239	5086	6782	13563

(Unit: Hour)

The table below shows the recording time in hours based on standardized general video signal. There may be a difference depending on the contents of the video input, motion and noise level.

HDD: 250GB
Resolution: 360 x 240
Video: 16 Channels
Audio: 8KB sampling rate

Quality \ FPS	7F/1S	3F/1S	2F/1S	1F/1S	1F/2S	1F/3S	1F/4S	1F/5S	1F/8S	1F/16S
Q7	48	113	170	339	678	1017	1356	1695	2713	5425
Q6	58	136	203	407	814	1221	1628	2035	3255	6510
Q5	63	147	220	441	882	1322	1763	2204	3526	7053
Q4	73	170	254	509	1017	1526	2035	2543	4069	8138
Q3	97	226	339	678	1356	2035	2713	3391	5425	10851
Q2	116	271	407	814	1628	2441	3255	4069	6510	13021
Q1	194	452	678	1356	2713	4069	5425	6782	10851	21701

(Unit: Hour)

HDD: 250GB
Resolution: 360 x 240
Video: 16 Channels
Audio: none

Quality \ FPS	7F/1S	3F/1S	2F/1S	1F/1S	1F/2S	1F/3S	1F/4S	1F/5S	1F/8S	1F/16S
Q7	53	124	186	373	746	1119	1492	1865	2984	5968
Q6	58	136	203	407	814	1221	1628	2035	3255	6510
Q5	68	158	237	475	949	1424	1899	2374	3798	7595
Q4	78	181	271	543	1085	1628	2170	2713	4340	8681
Q3	102	237	356	712	1424	2136	2848	3560	5697	11393
Q2	121	283	424	848	1695	2543	3391	4239	6782	13563
Q1	203	475	712	1424	2848	4272	5697	7121	11393	22786

(Unit: Hour)

Appendix D

Menu Tree

Main Menu

Camera Setup

- Channel Setup
- PTZ Model
- Video Format

Recording Setup

- Schedule
- Manual Recording
- Record Mode

Alarm Setup

- Alarm Outputs
- Event
- Alarm Name
- Alarm Buzzer

Display Setup

- User Defined Screen
- Sequence
- Spot Monitor
- Transparency

Audio Setup

Administration

- Language
- HDD Management
 - HDD Information
- Network Setup
- Date/Time Setup
 - Time Server Setup
 - Daylight Saving
- Password
 - Web Password
- Firmware Management
 - Update Firmware
 - Backup Firmware
- Covert Channel
- Mail Notification
 - Conditions
- Configuration Management
 - Backup to USB
 - Restore from USB
 - Factory Default
- Telemetry Control Setup
- System Information

HDD Backup

- Backup
- USB Backup
- CD Backup
- Erase CDRW

Event Log

Power

Appendix E

Specifications

VIDEO FORMAT	NTSC/PAL
COMPRESSION SYSTEM	Video: Wavelet, Audio: AC97(8/12bit, 8/12Khz)
DVR TYPE	Triplex (simultaneous Record, Playback, Live and Playback, LAN access)
OPERATING SYSTEM	Embedded Linux
VIDEO INPUT	16 x Composite 1.0Vp-p, 75 ohm BNC
VIDEO LOOP OUT	16 x Composite 1.0Vp-p, 75 ohm BNC
VIDEO OUTPUT	1 x Composite 1.0Vp-p, 75 ohm BNC 1 x S-Video Y: 1.0Vp-p, C: 0.286Vp-p 1 x SPOT Composite 1.0Vp-p, 75 ohm BNC
AUDIO INPUT	1 channel Mono, 8/12Khz sampling rate
AUDIO OUTPUT	1 channel Mono, -4dB RCA
SCREEN OPTIONS	1, 4, 9, 16, 6, 7,8, 10, 13, PIP, CIF
RECORD MODE	Continuous, Event, Manual
RECORD RATE	NTSC: 60 fps @ 720x240, 120 fps @ 360x240 PAL: 50 fps @ 720x280, 100 fps @ 360x280
RECORD RESOLUTION	NTSC: 720x240, 360x240 PAL: 720x280, 360x280
QUALITY LEVEL	7 levels
PRE- AND POST-ALARM	Yes
ALARM PROTECTION	Yes, via HDD partition
MOTION DETECTION	14 x 14 grid
ALARM INPUT	16
ALARM OUTPUT	4 (NC/NO, selectable)
TELEMETRY CONTROL	Pan, Tilt, Zoom, Focus, Iris, Preset and Tour via front panel, 2 simultaneous protocols
TELEMETRY PORTS	2 x full-duplex RS-422 or 1 x full-duplex RS-422 and 1 x half-duplex RS-485
NETWORK INTERFACE	1 x RJ-45, 10/100 Base-T Ethernet
REMOTE CONTROL	optional Keypad (RS-422), web browser or PC client software (via network)
INTERNAL HDD	4 x IDE ATA133 (1TB maximum)
EXTERNAL STORAGE	up to 20 IEEE 1394 (FireWire) devices
ARCHIVING	via USB or IEEE 1394 (FireWire) CD-R/RW, DVD-R/RW, HDD
TIME SYNCHRONIZATION	Automatic via SNTP or via RS-422 master/slave
DAYLIGHT SAVING	Yes
SEARCH MODE	Date/time, motion, alarm, video loss, menu change
SOFTWARE UPDATE	via USB or network (FTP)
NOTIFICATION	via SMTP e-mail
SECURITY	multi-level access control via user password
DATA INTEGRITY CHECK	watermark
DIMENSION	432mm x 88mm x 450mm (WxHxD)
WEIGHT	10Kg (without HDD)
MOUNTING	19" 2U rack mountable
POWER CONSUMPTION	50W
INPUT VOLTAGE	AC 115/230V \pm 10%, 50-60Hz, selectable
OPERATING TEMPERATURE	0 to 40° C
AMBIENT HUMIDITY	10 ~ 80%, no condensing

Notes



CBC Co., Ltd.
Tokyo. Japan
www.ganz.jp

P/NO: 3834RS0071X